

HTS SeaLand® Holding Tank Systems

Odor-Free, Premium-Quality Performance

Boatowners can now realize the benefits of a user-friendly, properly-sized holding tank in virtually any Type III MSD system with this wide selection of SeaLand holding tank systems. Both HTS-T and Basic series use top-mounted fittings and diptube discharge plumbing to prevent potential leaks. Multiple discharge outlets eliminate need for complex plumbing and extra discharge line connections.

HTS-T and Basic Series SeaLand Holding Tank Systems

- HTS-T models include T series discharge pump
- Corrosion-proof, leak-proof, odor-proof – high-density polyethylene tank construction
- “Diptube-style” discharge fittings for thorough, leak-proof pump-out
- All components pre-plumbed, pre-tested
- Easy to install – no solvent-bond connection required
- ISO/USCG compliant tanks



10 HTS-T
 Height: 13.25 in./635 mm
 Width: 19.5 in./495 mm
 Length: 23.375 in./594 mm

Item: 322721012 – 12V
 Item: 322721024 – 24V

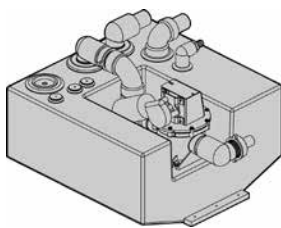

28 HTS-T
 Height: 19.5 in./495 mm
 Width: 19 in./483 mm
 Length: 30 in./762 mm

Item: 322012812 – 12V
 Item: 322012824 – 24V

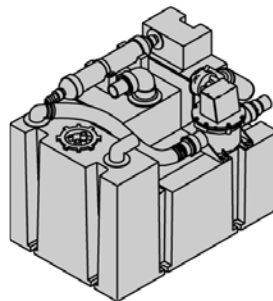

40 HTS-T
 Height: 20 in./508 mm
 Width: 21 in./533 mm
 Length: 35 in./889 mm

Item: 322014012 – 12V
 Item: 322014024 – 24V

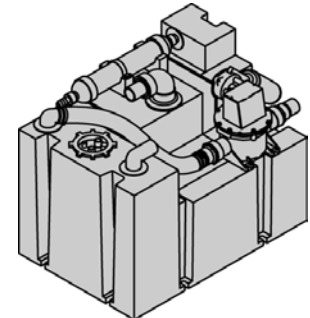

HTS-T Series SeaLand Holding Tank System Technical Specifications

MODEL	CAPACITY (GAL./LITERS)	EMPTY WEIGHT (LBS./KG)	MAX. WEIGHT (LBS./KG)	OUTLETS (QTY)	VENT FILTER
10 HTS-T	10 / 38	18 / 8.2	98 / 40.9	2	–
28 HTS-T	28 / 106	40 / 18	260 / 118	2	included
40 HTS-T	40 / 151	44 / 20	364 / 165	2	included

Dimensions include height of fittings and accessories

All HTS-T models shown here include SeaLand T-series discharge pump, DTM04 four-level tank monitor system, and TankSaver relief valve. Available in 12 V and 24 V DC systems. Specifications subject to change without notice.

HTS-T Series System Requirements

		DISCHARGE PUMP*	DTM04 TANK MONITOR
ELECTRICAL	Power draw (avg.)	6 amps/12 V DC 3 amps/24 V DC	0.15 amp/12 V DC 0.09 amp/24 V DC
	Circuit breaker/fuse	10 amps/12 V DC 5 amps/24 V DC	1 amp/12 V DC 1 amp/24 V DC
INLET PLUMBING	ID	1.5 in./38 mm sanitation hose or PVC pipe	

DISCHARGE PLUMBING	ID	1.5 in./38 mm sanitation hose or PVC pipe
	Horizontal run	30 ft./9.1 m max. to discharge fitting
	Vertical run	6 ft./1.8 m max. to discharge fitting
VENT HOSE	ID	5/8 in./16 mm sanitation hose

* Requires separate circuit breaker or fuse. Specifications subject to change without notice.

HTS-Basic Series SeaLand Holding Tank System Technical Specifications

MODEL	CAPACITY (GAL./LITERS)	EMPTY WEIGHT (LBS./KG)	MAX. WEIGHT (LBS./KG)
12 HTS-VRT	11 / 42	20 / 9.1	108 / 49
12 HTS-HRZ	11 / 42	20 / 9.1	108 / 49
12 HTS-HL	12 / 45	22 / 10	118 / 53.5
15 HTS-VRT	15 / 57	25 / 11.3	145 / 65.8
15 HTS-HRZ	15 / 57	25 / 11.3	145 / 65.8
20 HTS-VRT	18 / 68	27 / 12.2	171 / 77.6
20 HTS-HRZ	18 / 68	27 / 12.2	171 / 77.6

MODEL	CAPACITY (GAL./LITERS)	EMPTY WEIGHT (LBS./KG)	MAX. WEIGHT (LBS./KG)
25 HTS-HRZ	25 / 94	31 / 14.1	231 / 105
28 HTS-HL	28 / 106	37 / 16.8	261 / 118
30 HTS-HRZ	28 / 106	37 / 16.8	261 / 118
35 HTS-HL	35 / 132	38 / 17.2	318 / 144
40 HTS-HRZ	34 / 129	41 / 18.6	313 / 142
50 HTS-VRT-HL	50 / 189	53 / 24	453 / 205
50 HTS-HRZ-HL	50 / 189	53 / 24	453 / 205
55 HTS-HRZ	55 / 208	53 / 24	493 / 224
80 HTS-HRZ	80 / 302	54 / 24.5	694 / 315

HTS-Basic Series System Requirements

INLET PLUMBING	ID	1.5 in./38 mm sanitation hose or PVC pipe
DISCHARGE PLUMBING	ID	1.5 in./38 mm sanitation hose or PVC pipe
VENT HOSE	ID	5/8 in./16 mm sanitation hose

Specifications subject to change without notice.

12 HTS-VRT

Height: 17.75 in./451 mm
Width: 8.25 in./210 mm
Length: 24.5 in./622 mm
Item: 322840122

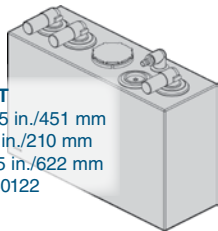

12 HTS-HRZ

Height: 0.75 in./273 mm
Width: 15.25 in./387 mm
Length: 24.5 in./622 mm
Item: 322840121

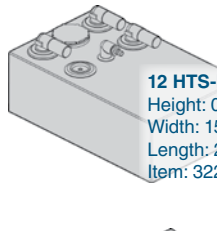

12 HTS-HL

Height: 12.25 in./311 mm
Width: 17.25 in./438 mm
Length: 30 in./762 mm
Item: 322800121

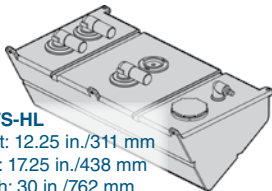

15 HTS-VRT

Height: 21.5 in./546 mm
Width: 12.5 in./318 mm
Length: 22 in./559 mm
Item: 322840152

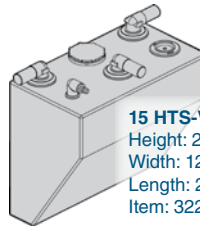

15 HTS-HRZ

Height: 15 in./381 mm
Width: 19 in./483 mm
Length: 22 in./559 mm
Item: 322840151

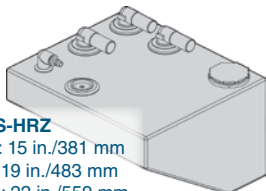

20 HTS-VRT

Height: 16.75 in./425 mm
Width: 11.5 in./292 mm
Length: 28.28 in./718 mm
Item: 322840202

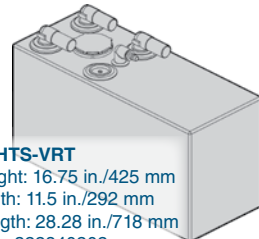

20 HTS-HRZ

Height: 14 in./356 mm
Width: 14.25 in./362 mm
Length: 28.25 in./718 mm
Item: 322840201

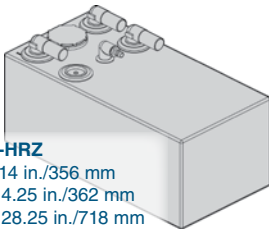

25 HTS-HRZ

Height: 20.5 in./521 mm
Width: 17 in./432 mm
Length: 21 in./533 mm
Item: 322800251

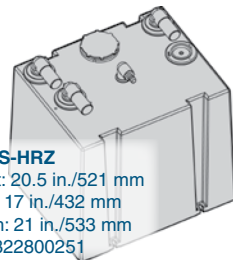

28 HTS-HL

Height: 14.25 in./362 mm
Width: 23.5 in./597 mm
Length: 35.25 in./895 mm
Item: 322800281

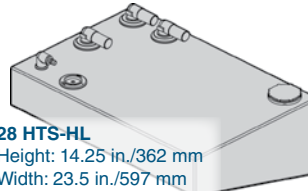

30 HTS-HRZ

Height: 14.5 in./368 mm
Width: 20 in./508 mm
Length: 30 in./762 mm
Item: 322840301

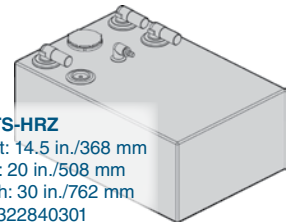

40 HTS-HRZ

Height: 16 in./406 mm
Width: 21.75 in./552 mm
Length: 30 in./762 mm
Item: 322840401

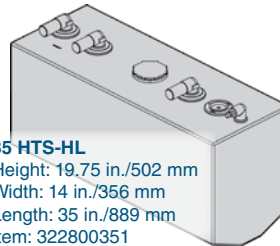

Dimensions include height of fittings and accessories

35 HTS-HL

Height: 19.75 in./502 mm
Width: 14 in./356 mm
Length: 35 in./889 mm
Item: 322800351

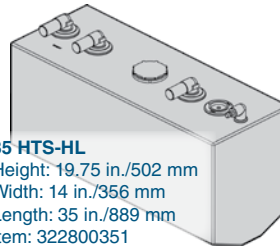

50 HTS-VRT-HL

Height: 33.25 in./845 mm
Width: 19 in./483 mm
Length: 22 in./559 mm
Item: 322850501

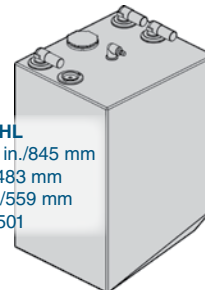

55 HTS-HRZ

Height: 18.5 in./470 mm
Width: 20 in./508 mm
Length: 40 in./1016 mm
Item: 322840551

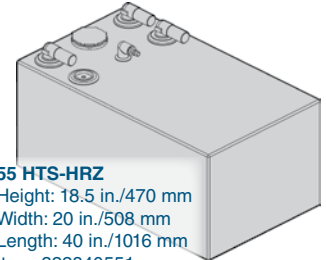

50 HTS-HRZ-HL

Height: 21.375 in./543 mm
Width: 22 in./559 mm
Length: 30.75 in./781 mm
Item: 322850502

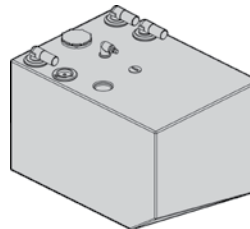

80 HTS-HRZ

Height: 12.5 in./318 mm
Width: 28 in./711 mm
Length: 76 in./1930 mm
Item: 322800801

